

DELTA 35

CAPACITY Kg 3500

ELECTRO-HYDRAULIC TWO-POST LIFT WITH EXTRA LOW ARMS
 ELEKTROHYDRAULISCHE 2-SÄULEN HEBEBÜHNEN MIT FLACHEN TRAGARMEN
 ÉLÉVATEUR 2 COLONNES ÉLECTRO-HYDRAULIQUE AVEC BRAS SURBAISSÉS
 ELEVADOR ELECTRO-HYDRAULICO DOS COLUMNAS CON BRAZOS EXTRAPLANOS



DELTA 35 H

TECHNICAL DATA - TECHISCHE DATEN - DONNÉES TECHNIQUES - DATOS TÉCNICOS

DELTA 35

Max. capacity	Portata max.	Tragfähigkeit max.	Portée max.	Capacidad máxima	kg	3500
Lifting time	Tempo di salita	Hubzeit	Temps de montée	Tiempo de subida	sec	39
Lowering time	Tempo di discesa	Senkzeit	Temps de descente	Tiempo de bajada	sec	39
Electric motor	Motore elettrico	Elektromotor	Moteur électrique	Motor eléctrico	Volt - A - Hz	230/400 - 12,6/7,4 - 50
Electric motor power	Potenza motore	Motorleistung	Puissance du moteur	Potencia motor	Kw- Hp	2,6-3,5
Max working pressure	Pressione idraulica max. di esercizio	Max Arbeitsdruck	Pression hydraulique max. d'exercice	Presión hidráulica máxima de funcionamiento	bar	220
Control circuit tension	dei comandi Tensione circuito	Steuerspannung	Tension du circuit des commandes	Tensión circuito de mandos	Volt	24
Oil type	Olio consigliato	Öltyp	Huile conseillée	Aceite recomendado	o	ESSO NUTO H32 equivalente (ISO VG32)
Oil quantity	Quantità olio impianto idraulico	Ölfüllmenge	Quantité d'huile de l'installation hydraulique	Cantidad de aceite equipo hidráulico	l	13

DELTA 35

(2 SFILI - ARMS WITH 2 SECTIONS)



DELTA 35 P

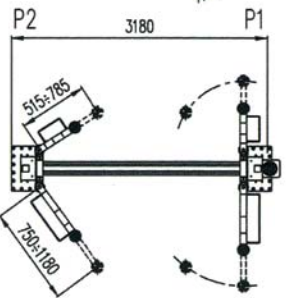
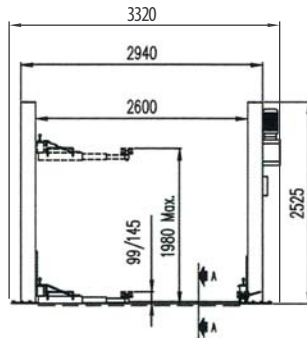

DELTA 35 B

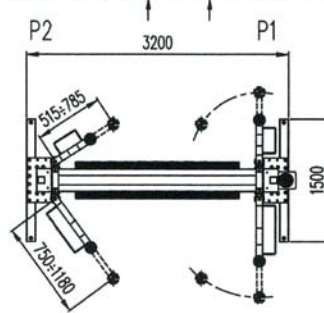
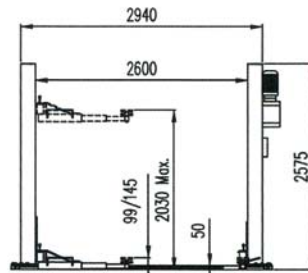

DELTA 35 H

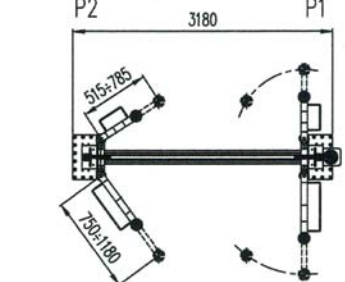
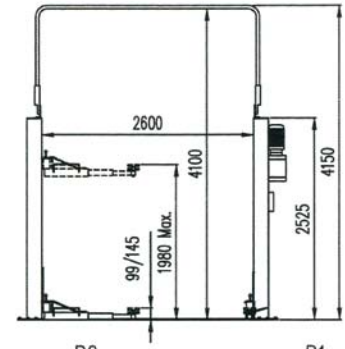

OPTIONAL DELTA 35 S

(3 SFILI - ARMS WITH 3 SECTIONS)

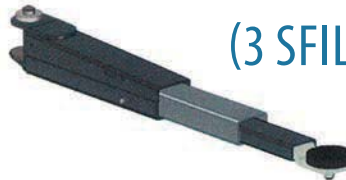

DELTA 35 PS

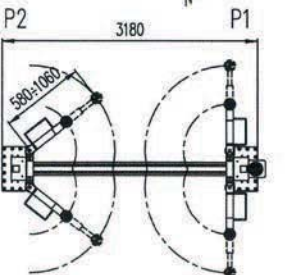
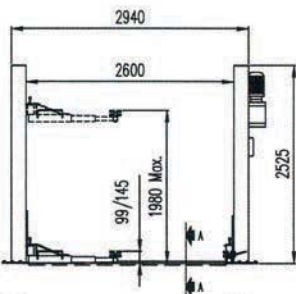

DELTA 35 BS

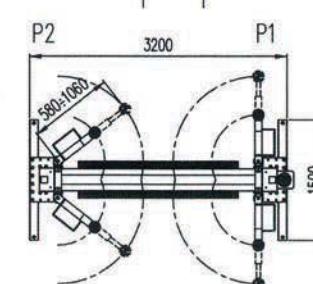
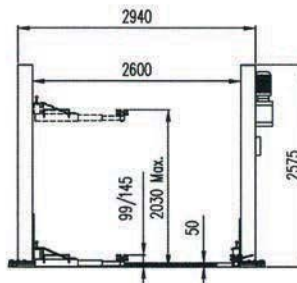

DELTA 35 HS

